

SKA0052 Instructions

53514

Subject

Instructions for exchanging original control box with Power Zone™ control box.

Models Affected

MLT4060K light tower

Table of Contents

	Page
Introduction	1
Recommended Tools	2
SKA0052 Kit Components	2
Remove Old Control Box	3
Install Power Zone Control Box.....	13
Power Zone Controller	22
Manually Starting Unit.....	29
Auto (Remote) Starting of Unit.....	30
Light Operation.....	31
Auto Exercise Timer.....	31
Resetting Maintenance Alarms	34
Shutting Down the Unit	35
AC Wiring Diagram	36
DC Wiring Diagram	37

Introduction

The following instructions illustrate exchanging original control box with Power Zone™ control box on MLT4060K light tower.

Note: Before beginning these procedures, verify kit components listed on page 2 are present. If items are missing, contact Generac Mobile Products LLC at 1-800-926-9768.

⚠ WARNING

Consult Manual. Read and understand manual completely before using product. Failure to completely understand manual and product could result in death or serious injury. (000100a)

⚠ WARNING

Accidental Start-up. Disconnect the negative battery cable, then the positive battery cable when working on unit. Failure to do so could result in death or serious injury. (000130)

⚠ WARNING

California Proposition 65. Engine exhaust and some of its constituents are known to the state of California to cause cancer, birth defects, and other reproductive harm. (000004)

⚠ WARNING

California Proposition 65. This product contains or emits chemicals known to the state of California to cause cancer, birth defects, and other reproductive harm. (000005)

Recommended Tools

- 1/2 in. wrench
- 9/16 in. wrench
- 9/16 in. socket with extension
- 7 mm wrench
- 17 mm wrench
- 7/16 in. wrench
- 3/8 in. wrench
- Diagonal cutter
- Phillips screwdriver

SKA0052 Kit Components

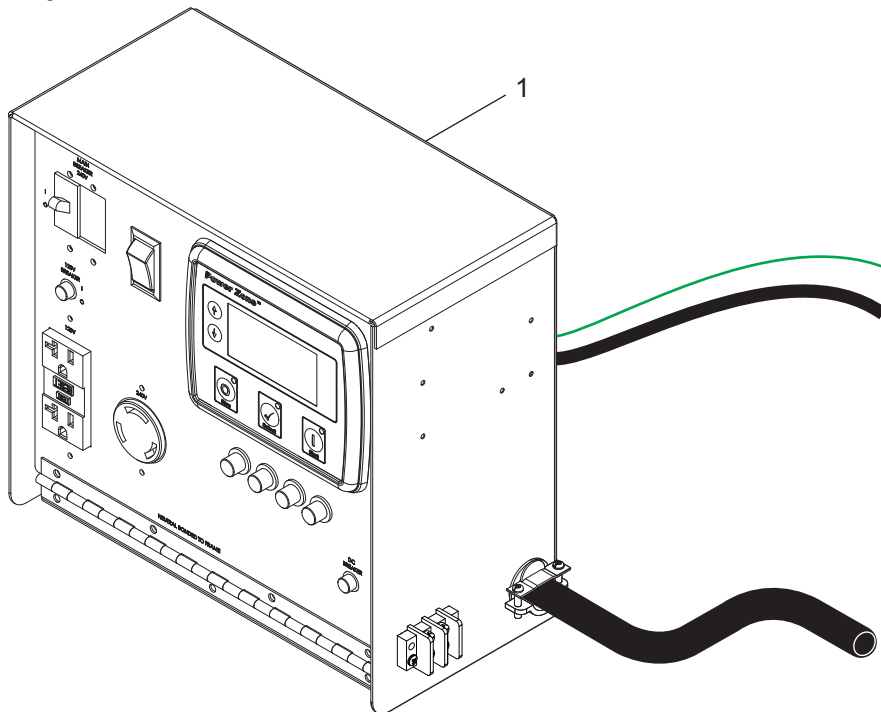

Figure 1 - SKA0052 Kit Components

Item	Part No.	Qty	Description	Notes
1	69841	1	Assembly, complete box, Kubota, 6kw, PZ	
--	49613	8	Cable tie, 8.00 in. x .142 - red	

Remove Old Control Box

1. Verify unit is OFF.
2. See [Figure 2](#). Disconnect negative battery cable and secure terminal away from battery.



Figure 2 - Negative Battery Cable, Secured Away from Battery

3. Disconnect all engine harness wires, as follows.

Note: When disconnecting an engine harness wire, cut and discard cable-ties securing the wire.

a. See [Figure 3](#). Disconnect violet/yellow and black/white wires that connect to fuel pump wires.



Figure 3 - Fuel Pump Wires

Item	Description
A	Fuel pump wires
B	Violet/yellow wire
C	Black/white wire

b. See [Figure 4](#). Disconnect coolant temperature switch wire.

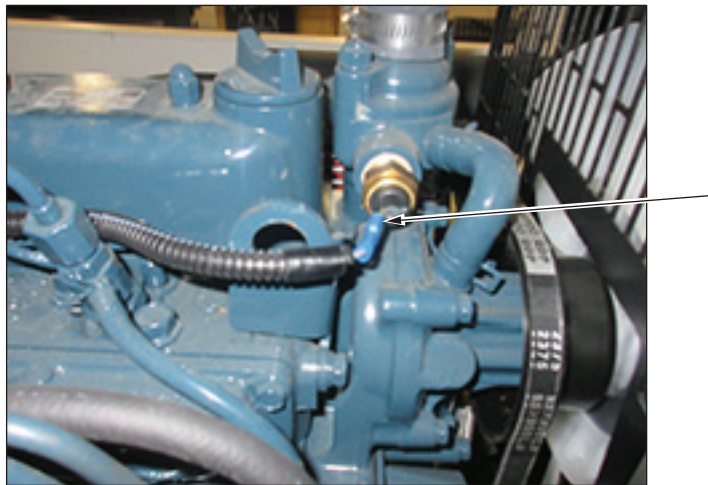

Figure 4 - Coolant Temperature Sensor Wire (Top of Engine)

- c. See [Figure 5](#). Disconnect glow plug wire.

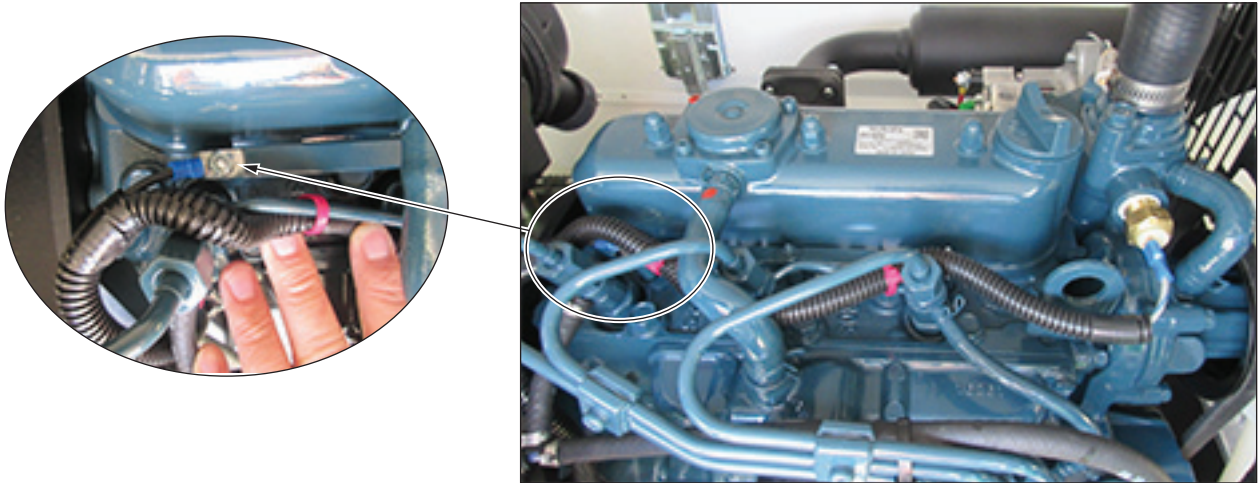

Figure 5 - Glow Plug Wire

- d. See [Figure 6](#). Disconnect fuel solenoid plug from the fuel solenoid.



Figure 6 - Fuel Solenoid Plug

- e. See [Figure 7](#). Disconnect engine ground wire.



Figure 7 - Engine Ground Wire

- f. See [Figure 8](#).
- Disconnect red/violet wire from alternator.
 - Disconnect orange and red/white wires from starter.

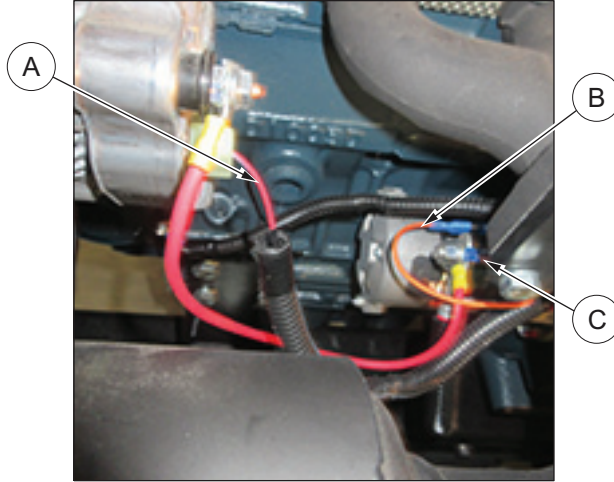

Figure 8 - Alternator and Starter Wires

Item	Description
A	Red/violet wire (alternator)
B	Orange wire (starter)
C	Red/white wire (starter)

- g. See [Figure 9](#). Disconnect oil pressure switch wire.

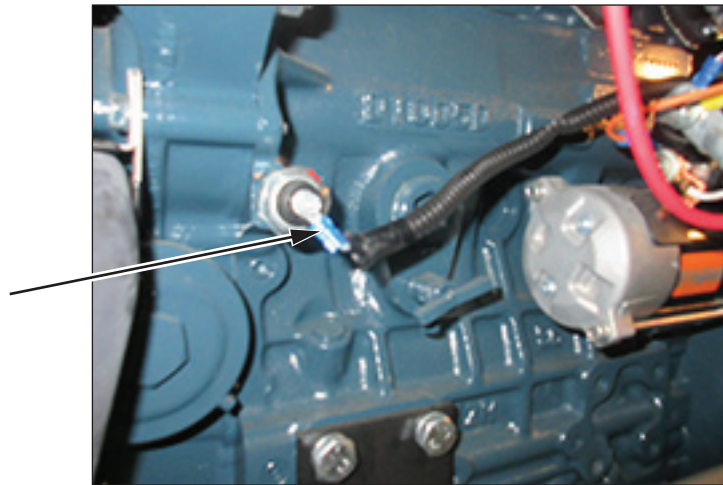

Figure 9 - Oil Pressure Switch Wire

4. Disconnect generator box wires, as follows.
 - a. See [Figure 10](#). Remove generator box cover. Retain cover and hardware.

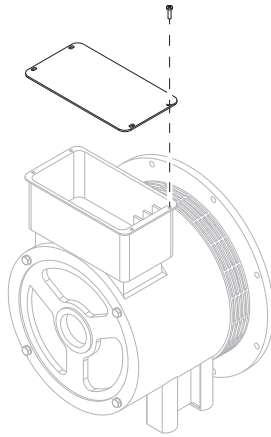

Figure 10 - Generator Box Cover

- b. See [Figure 11](#).
 - i. Disconnect black, white, and red wires from terminals.
 - ii. Loosen strain relief.

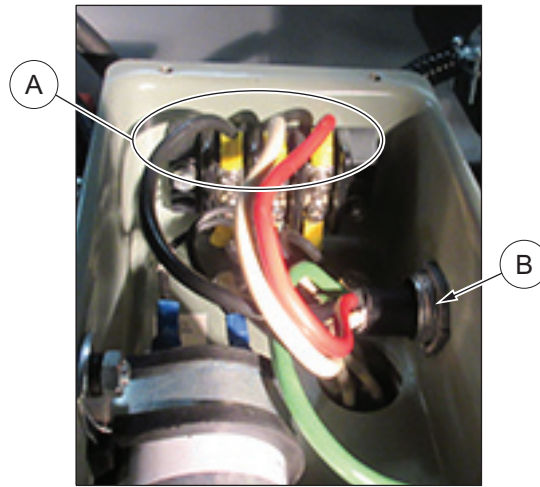

Figure 11 - Generator Box Wires and Strain Relief

Item	Description
A	Black, white, and red wires
B	Strain relief

- c. Remove wires from box.

5. See [Figure 12](#). Disconnect both wires from ground stud in unit chassis. Retain hardware.

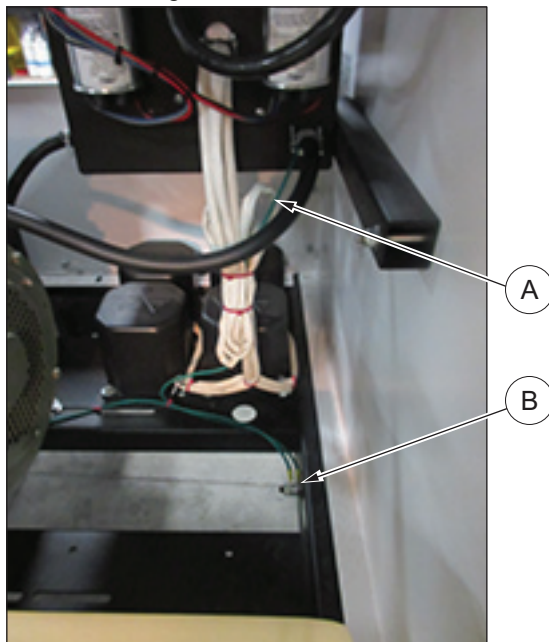

Figure 12 - Ground Wire to Chassis Ground Stud

Item	Description
A	Control box ground wire
B	Ground stud in unit chassis Secures two ground wires—control box and generator box

6. See [Figure 13](#). On back of control box, loosen the **upper** and **middle** strain reliefs.

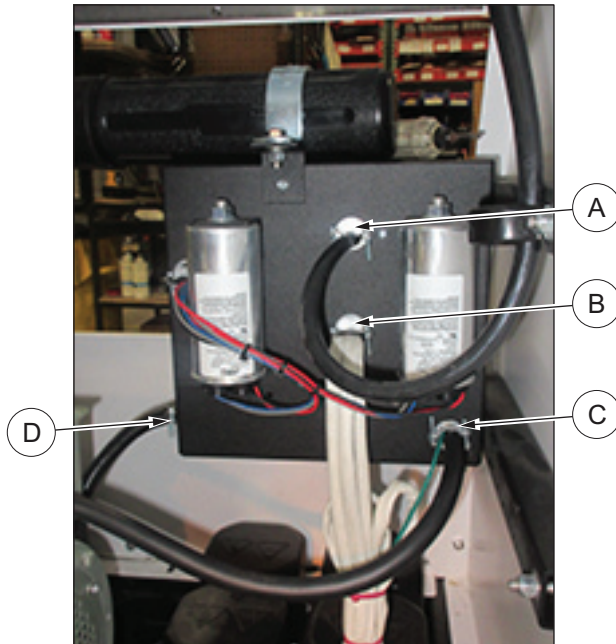

Figure 13 - Control Box Strain Reliefs

Item	Strain Relief Description	Cable Identification
A	Upper	Mast
B	Middle	Transformer
C	Lower	Generator box
D	Side	Engine harness

7. See [Figure 14](#). Remove screws securing panel to control box. Open control box.

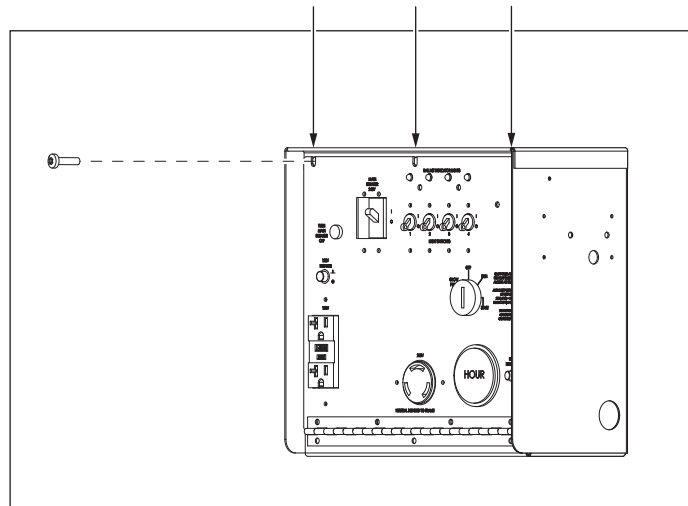

Figure 14 - Screws Securing Panel to Control Box

8. See *Figure 15*. In control box, disconnect all wires passing through upper and middle strain reliefs.

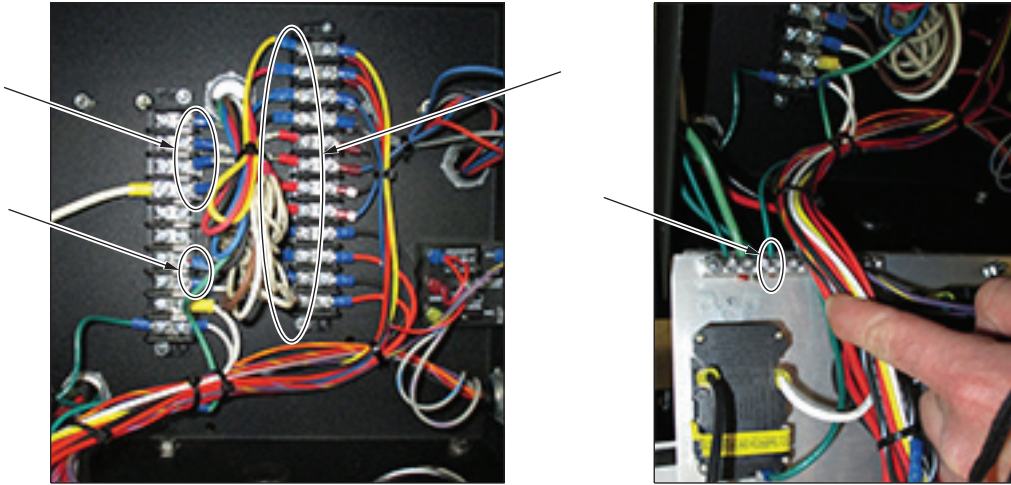

Figure 15 - Wires Passing Through Upper and Middle Strain Reliefs

9. See *Figure 16*. Remove cables from upper and middle strain reliefs.

Note: *Cut cable-ties as necessary to ease removal of cables.*

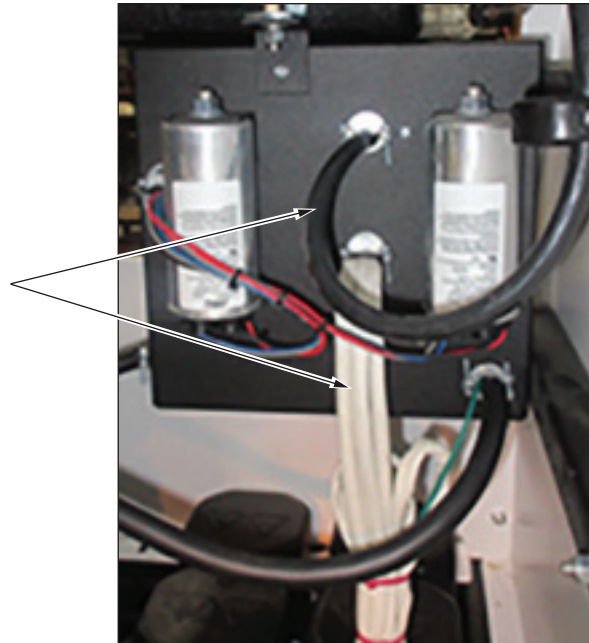

Figure 16 - Remove Cables

10. See [Figure 17](#). Remove hardware securing control box to unit. Retain hardware and control box.

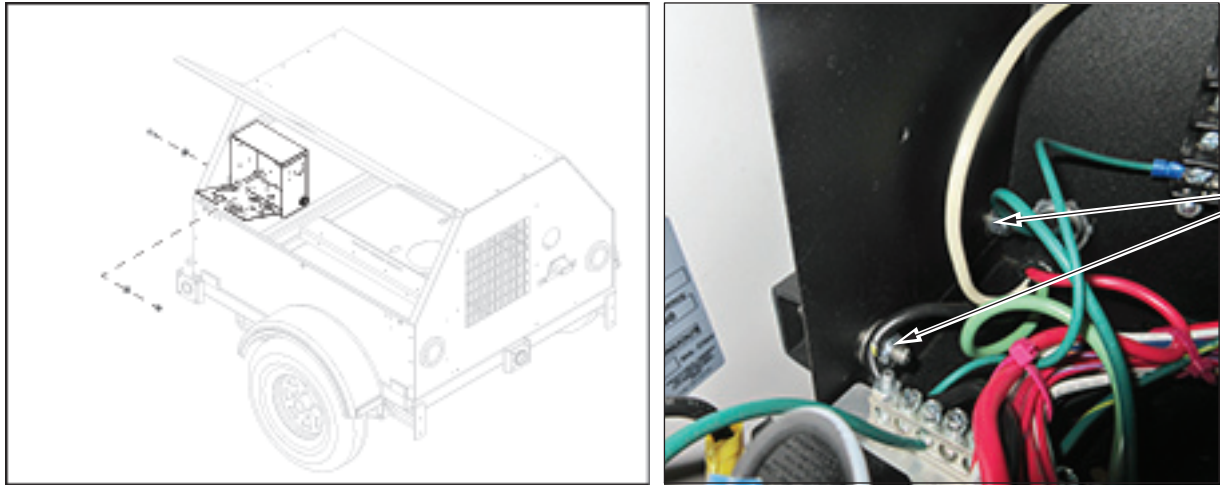

Figure 17 - Control Box to Unit: Four Hardware Locations

11. Choose the applicable step:

- **For units with Auto-Light unit on control box:**
See [Figure 18](#). Remove and retain manual holder.

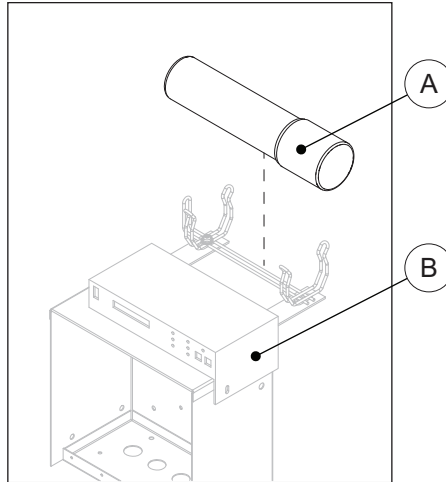

Figure 18 - Manual Holder on Box With Auto-Light Unit

Item	Description
A	Manual holder
B	Auto-Light unit

- **For units without Auto-Light unit:**
See [Figure 19](#). Remove and retain all manual holder components and hardware from control box.

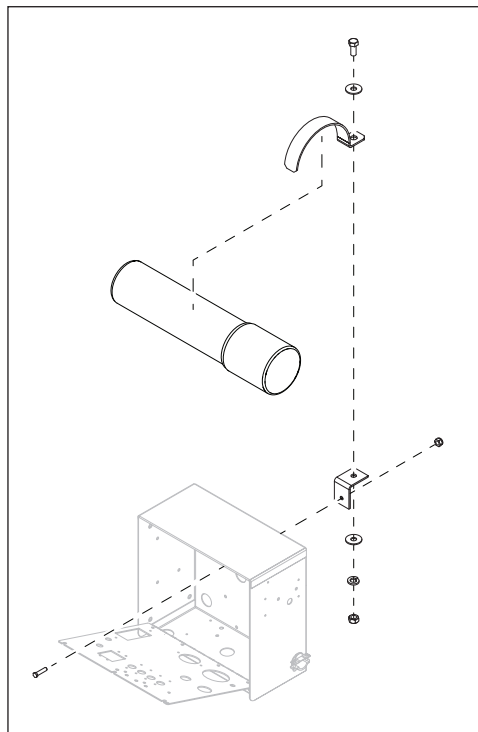

Figure 19 - Manual Holder on Box Without Auto-Light Unit

12. Discard control box and remaining components.

Install Power Zone Control Box

1. Open control panel on **new** control box (PN 69841).
2. See [Figure 20](#). Near top of box, locate bolt and nut that pass through box. Then, do the following:
 - Remove and retain nut
 - Leave screw in place

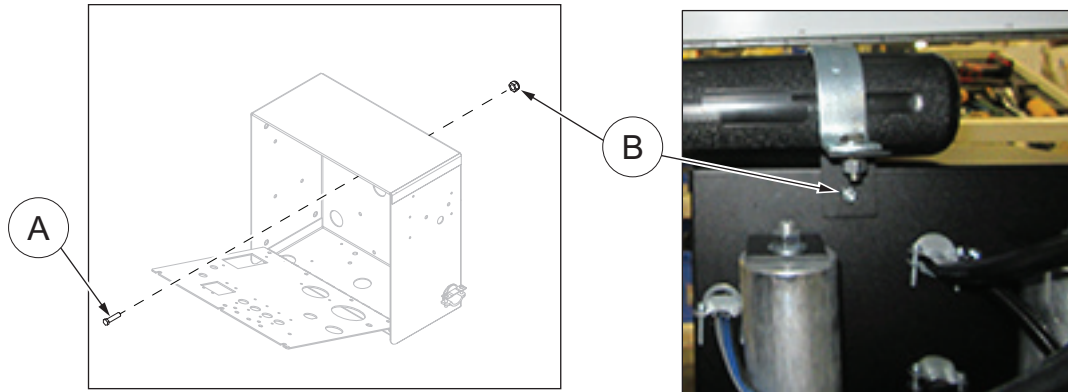

Figure 20 - Location of Bolt and Nut

Item	Description
A	Bolt
B	Screw

3. Obtain manual holder parts retained in step 11 of [Remove Old Control Box](#).

4. See [Figure 21](#). Attach manual holder to control box, as shown.

Note: Auto-Light units do not have all parts shown below. To obtain missing parts, contact Technical Service and order the needed part numbers, provided in the table below.

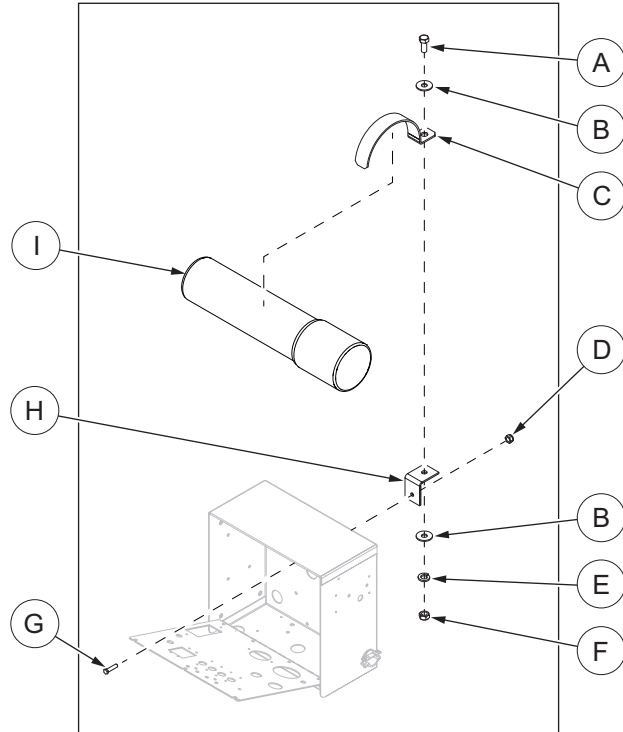

Figure 21 - Manual Holder Components

Item	PN	Description
A	60690	Screw
B	60698	Washer
C	10241	Clamp
D	—	Nut <ul style="list-style-type: none"> • Native to control box • Removed and retained in step 2
E	60698	Split-lock washer
F	60140	Nut
G	—	Screw—native to control box
H	32731B	Bracket
I	—	Manual holder—retained in step 11 of Remove Old Control Box

5. See [Figure 17](#). Install control box in unit with hardware retained in step 10 of [Remove Old Control Box](#).
6. See [Figure 22](#). Route the generator box cable and ground wire, as follows.

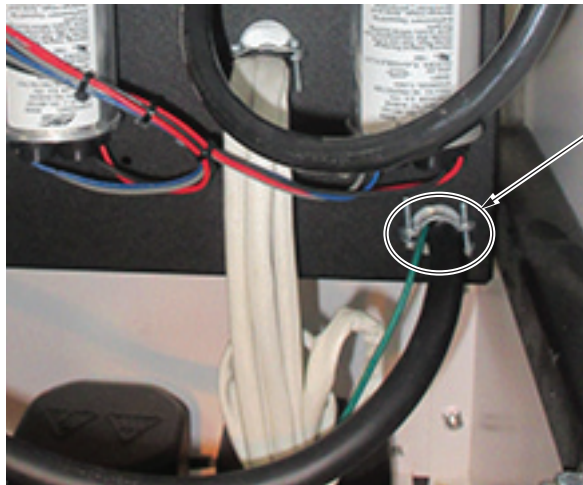

Figure 22 - Generator Box Cable and Ground Wire

- Cable: Route to generator box, through generator box strain relief, and into generator box
- Ground wire: Route to ground stud in unit chassis ([Figure 12](#))

Note: Do not connect wires until instructed.

7. See [Figure 11](#). Connect generator box wires, routed into generator box in step 6, to generator box terminals, in the following order.
 - a. Black
 - b. White
 - c. Red
8. See [Figure 10](#). Install generator box cover with hardware removed in step 4a of [Remove Old Control Box](#).
9. Route mast cable into control box by way of **top** strain relief.
10. See [Figure 23](#). Connect mast wires, as shown.

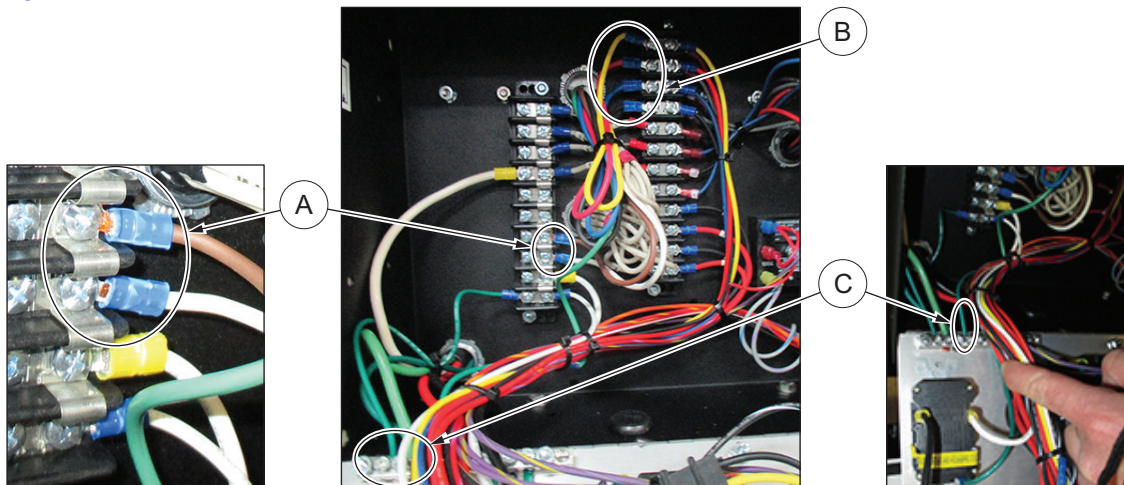

Figure 23 - Connect Mast Wires

Item	Description
A	Brown and white wires
B	Yellow, red, blue, and black wires
C	Green (ground) wire

11. Route transformer cable into control box, by way of **middle** strain relief.
12. See [Figure 24](#). Connect transformer wires, as shown.

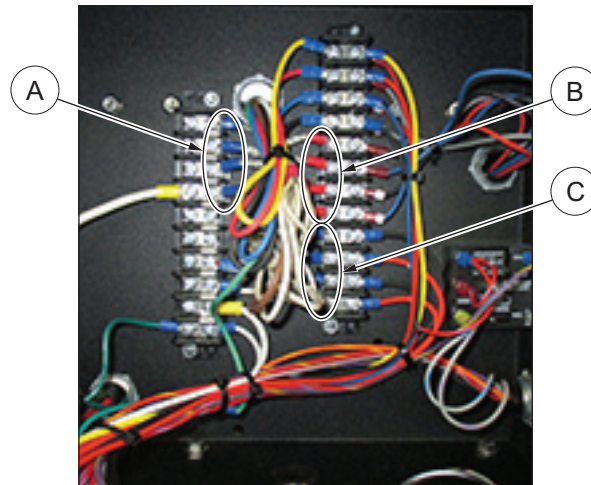

Figure 24 - Connect Transformer Wires

Item	Description
A	COMS wires
B	120 wires
C	CAPS wires

Note: Writing on the transformer wires identifies them as COMS, 120, or CAPS.

13. See [Figure 25](#). Locate engine harness (exits control box through **side** strain relief). Connect wires, as follows.

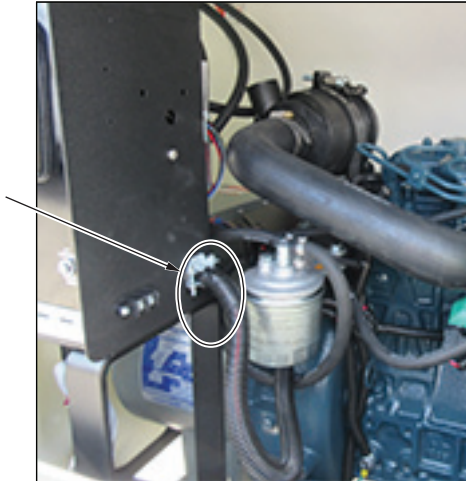

Figure 25 - Engine Harness from Control box

- a. See [Figure 7](#). Connect ground wire to engine block.
- b. See [Figure 6](#). Connect fuel solenoid plug to fuel solenoid.
- c. Route black/white wire with blue ring terminal to ground stud in unit chassis ([Figure 12](#)).

Note: Do not connect black/white wire until instructed.

- d. See [Figure 26](#). Route gray/blue wire to coolant temperature switch, as shown. Secure wire to engine with two cable-ties.

Note: The gray/blue wire is wrapped in black looming, as shown.



Figure 26 - Route Gray/Blue Wire to Coolant Temperature Switch

Item	Description
A	Suggested route of gray/blue wire
B	Destination of gray/blue wire—coolant temperature switch

- e. See [Figure 5](#). Connect glow plug wire (black wire with blue ring terminal) to rail.

f. See [Figure 27](#). Connect fuel pump wires and secure with cable-tie, as shown.

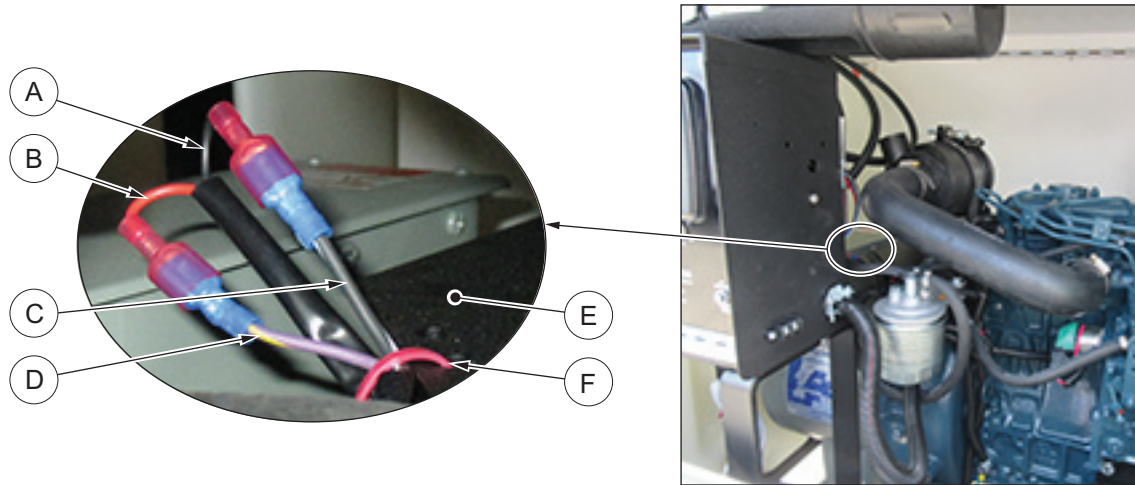

Figure 27 - Fuel Pump Wires and Securing Them

Item	Description	Notes
A	Unit wire—Black	Unit wires are bound together in black shrink-wrap, forming a black cable that originates at the fuel pump.
B	Unit wire—Red	
C	Engine harness wire—Black/white	
D	Engine harness wire—Violet/yellow	
E	Fuel filter/pump bracket	
F	Zip tie	Secures all wires to fuel filter/pump bracket

Connecting Fuel Pump Wires

Engine Harness Wire	To Unit Wire
Black/white	Black
Violet/yellow	Red

- g. See [Figure 28](#). Eliminate *most* slack in engine harness wires (on fuel solenoid side of engine) by bundling and cable-tying the wires, as shown.

NOTICE

When bundling wires, allow some slack to remain or damage to wires and connections may result.



Figure 28 - Bundle and Cable-Tie Harness Wires

- h. See [Figure 29](#). Connect orange wire with green plug to alternator.



Figure 29 - Alternator Connection

- i. See [Figure 30](#). Connect gray/violet wire to oil pressure switch.

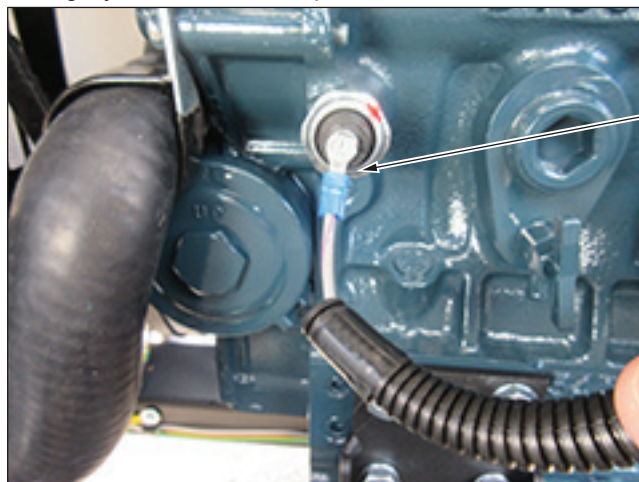

Figure 30 - Connect Oil Pressure Switch Wire

- j. See [Figure 31](#). Connect red wires to starter, as follows.

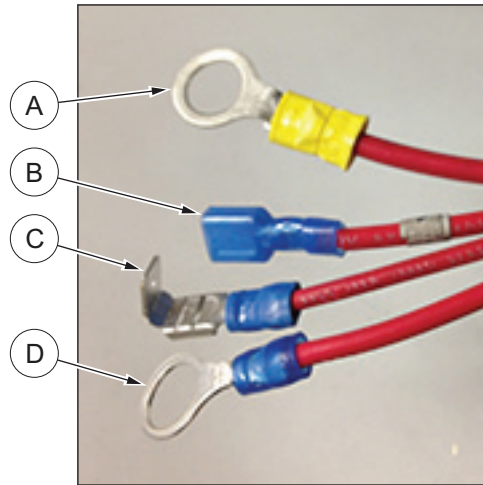

Figure 31 - Starter Wires

Item	Wire Description
A	Ring terminal—yellow
B	Spade terminal
C	Piggyback terminal
D	Ring terminal—blue

- i. See [Figure 32](#). Attach blue and yellow ring terminals to main starter stud.
 ii. Attach spade terminal to piggyback terminal; then attach to starter solenoid terminal.

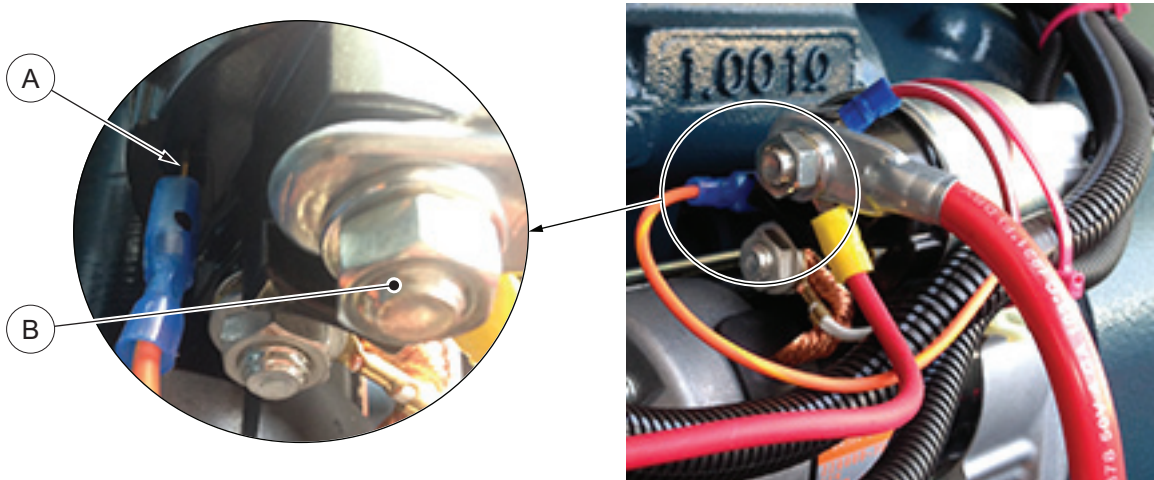

Figure 32 - Connection Points on Starter

Item	Description
A	Starter solenoid terminal
B	Main starter stud

iii. See [Figure 33](#). Zip-tie red wires and engine harness to the starter, as shown.

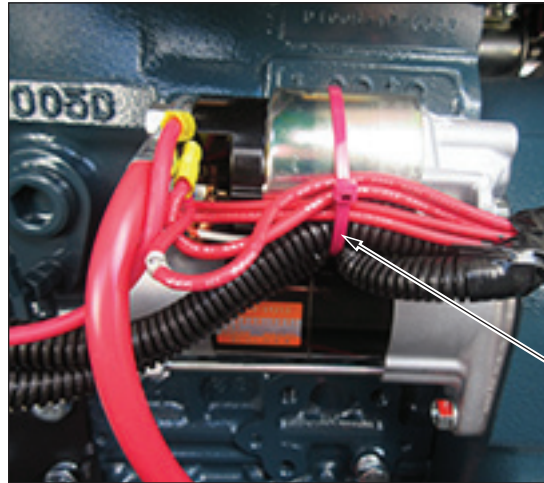

Figure 33 - Starter Wires

14. See [Figure 34](#). Connect ground wires to ground stud in unit chassis, as shown.

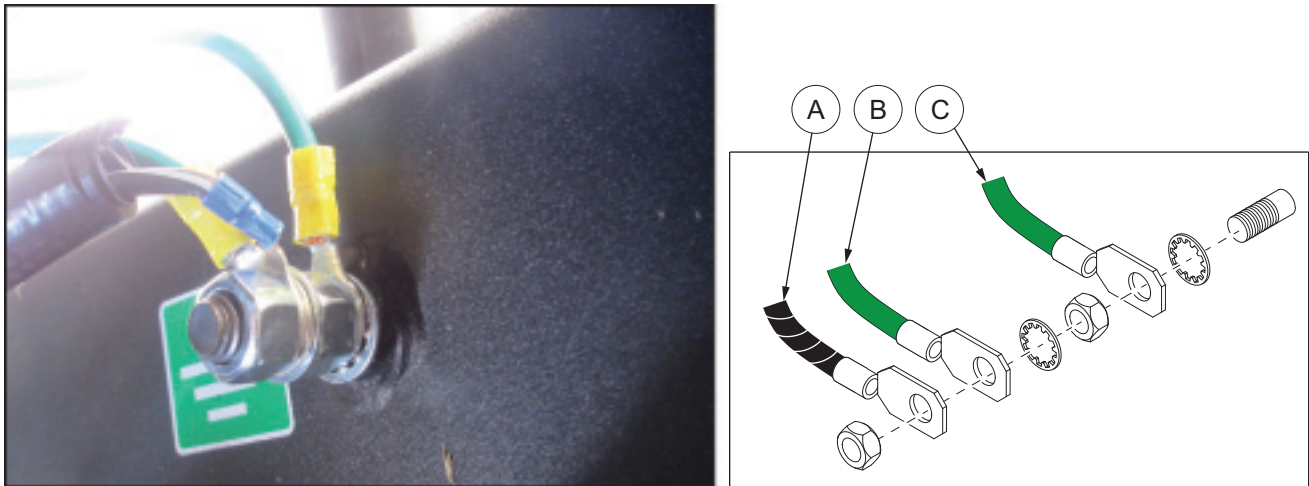

Figure 34 - Chassis Ground Stud

Item	Ground Wire Description
A	Engine harness (routed in step 13c)
B	Generator box (routed in step 6)
C	Control box (disconnected in step 5 of Remove Old Control Box)

15. See [Figure 13](#). Tighten strain reliefs on control box.

16. Attach negative battery cable to battery.

Power Zone Controller

The Power Zone controller monitors functions of the generator and engine; and can start and stop the unit according to a schedule, fault conditions, and load demand. The display shows operational status and fault conditions. If a fault condition occurs, the controller can shut down the engine and display the applicable fault.

Note: To resume operation, the fault condition must be resolved.

The controller also records unit performance history, which can be viewed any time and is not lost when the controller is powered down.

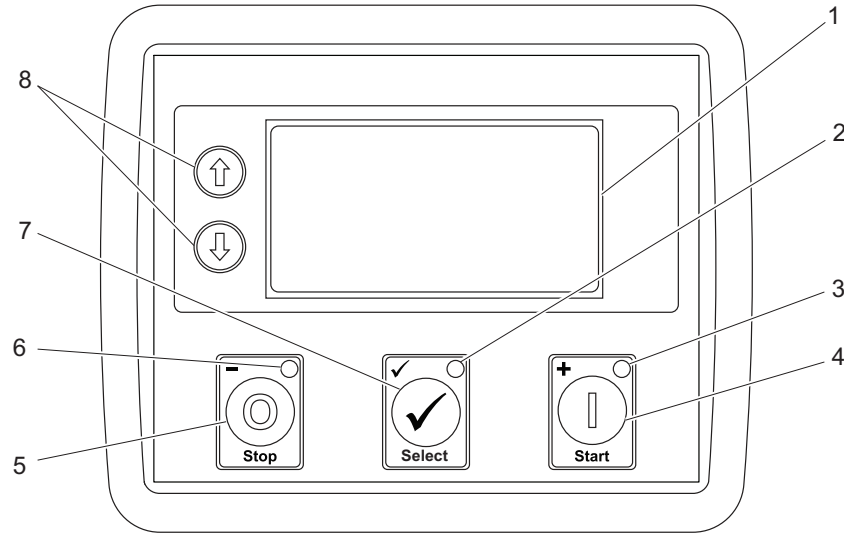

02017

Figure 35 - Power Zone Controller

Item	Description
1	<ul style="list-style-type: none"> Controller display Displays real-time monitoring information, fault information, and navigable menus and lists
2	<ul style="list-style-type: none"> Select LED Lit when unit is running in AUTO mode
3	<ul style="list-style-type: none"> Start LED Lights when unit is running in MANUAL mode
4	<ul style="list-style-type: none"> Start button Starts engine (provided no shutdown errors are present and engine satisfies start status)
5	<ul style="list-style-type: none"> Stop button Stops engine and places controller in STOP mode (regardless of MANUAL or AUTO mode)
6	<ul style="list-style-type: none"> Stop LED Lights when unit is in STOP mode Flashes during <i>electrical trip</i> and <i>shutdown</i> faults
7	<ul style="list-style-type: none"> Select button To choose menu and list items
8	<ul style="list-style-type: none"> Navigation arrow buttons To navigate menus and lists

⚠ CAUTION

In case of an emergency, always press the emergency stop switch located on the side of the unit to stop the engine immediately. The Stop (O) button may delay the engine shutdown if stop faults exist.

NOTICE

To prevent damage to the generator and connected equipment, remove all loads from the generator by opening all circuit breakers (turn to the OFF (O) position) before pressing the Stop (O) button.

Operator Screens

The operator screens display the most relevant and critical information an operator will need to properly configure and utilize a unit. From these six screens, the operator can access information necessary to operate the unit under normal conditions.

Home Screen

The Home screen is the default screen of the controller and will display after the controller is powered up and the unit management software is loaded. It displays which mode the controller is in, the total operated hours, the hours left until the next service interval, the engine operation status, and the engine RPM. If the unit is in AUTO mode, the Home screen may also display whether the scheduler or dawn to dusk are enabled.

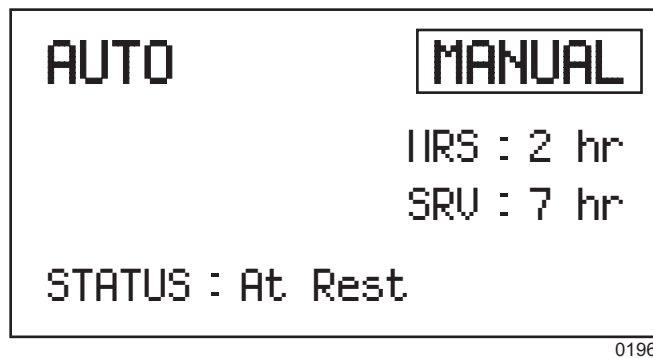

Figure 36 - Home Screen

Engine Screen

The Engine screen will display the battery voltage, oil pressure, coolant temperature and fuel level.

- VBAT: Displays the engine battery voltage. A normal reading is 12-14V on 12 volt systems and 24-26V on 24 V systems (with the engine running).
- OIL: Displays engine oil pressure. Normal operating pressure is between 35-80 psi (241-552 kPa).
- TEMP: Displays engine coolant temperature. Normal operating temperature of the unit is between 100-230°F (38-110°C).

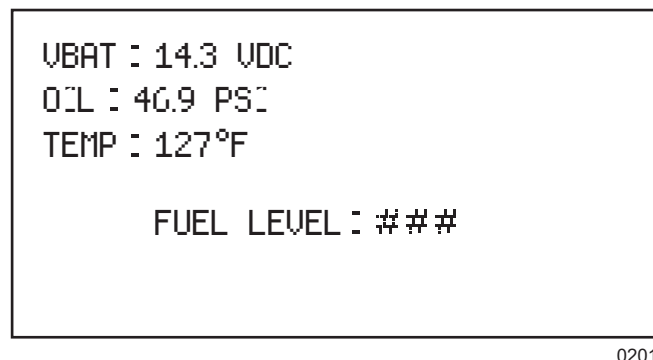
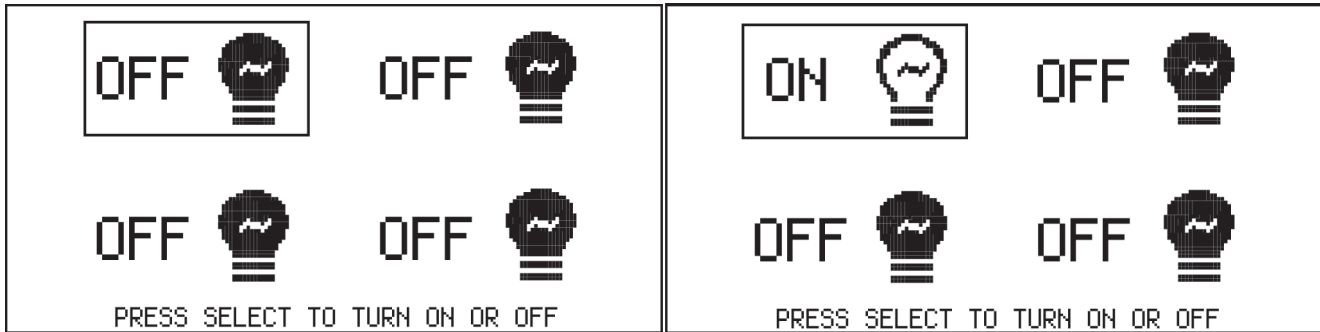

Figure 37 - Engine Screen

Lights Screen

The Lights screen provides access to turning on and off the lights.



01972

Figure 38 - Lights Screen

Dusk to Dawn Screen

The Dusk to Dawn screen provides access to turning the dusk to dawn capability of the lights on or off.

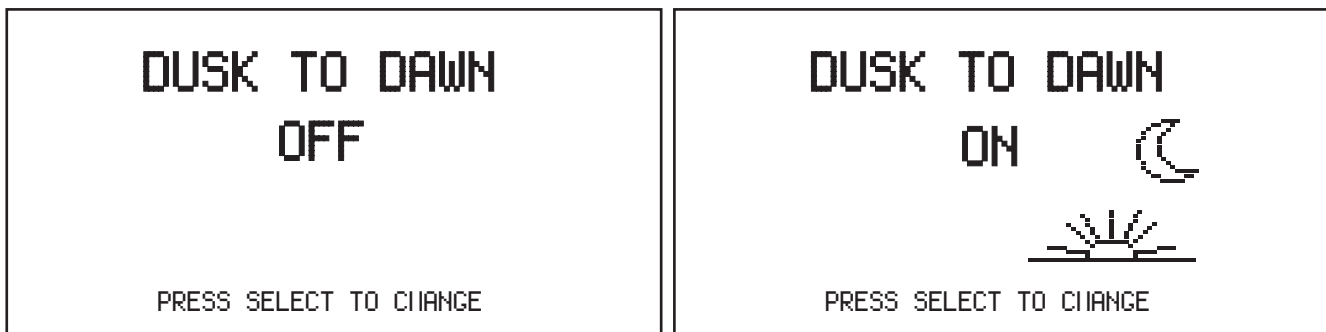

01971

Figure 39 - Dusk to Dawn Screen

Note: This feature only works in AUTO mode and with a photo sensor.

Scheduler Screen

The Scheduler screen provides access to turning the scheduler capability on or off.

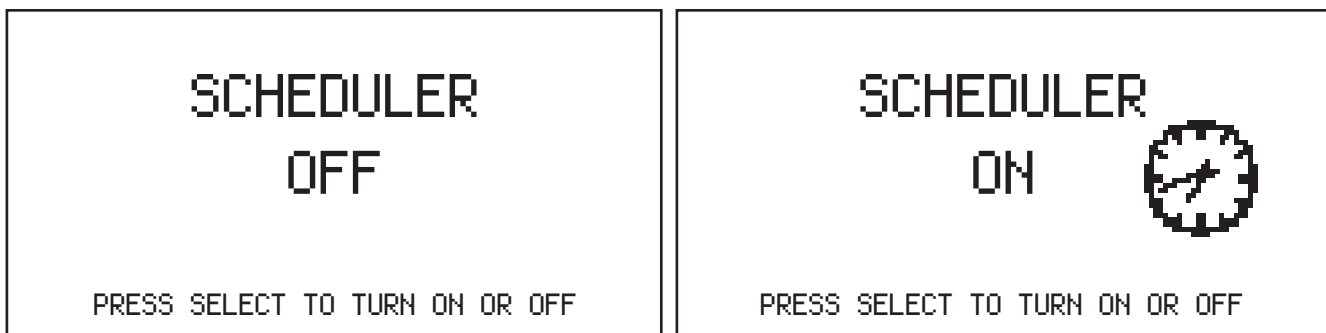

02014

Figure 40 - Scheduler Screen

Note: This feature only works in AUTO mode.

Maintenance Screens

The information displayed on the maintenance screens can be used to identify, diagnose and troubleshoot unit shutdown conditions and poor unit performance. Access the navigation menu as follows:

1. Simultaneously press the ↑ and ↓ buttons. The Navigation menu displays.

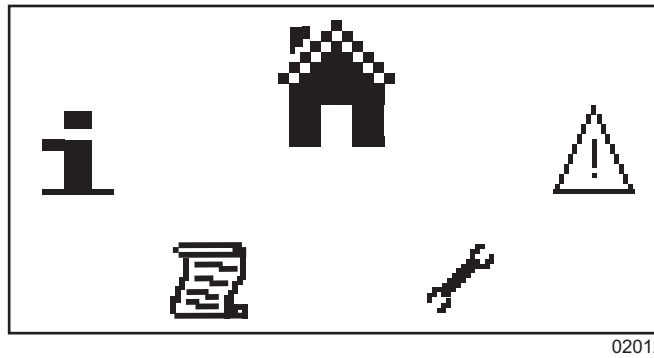







Figure 41 - Navigation Menu

2. Scroll through the menu icons by pressing the ↑ or ↓ button.

3. When the desired icon is at the top, press the Select (✓) button to display the corresponding screen.

Icon	Description
	Home screen
	Alarms screen
	Maintenance screen
	Event log screen
	About screen

Home Screen

The Home () screen is the default screen of the controller and displays upon controller power-up. Regardless of what function is selected, a period of prolonged inactivity causes the Home screen to display.

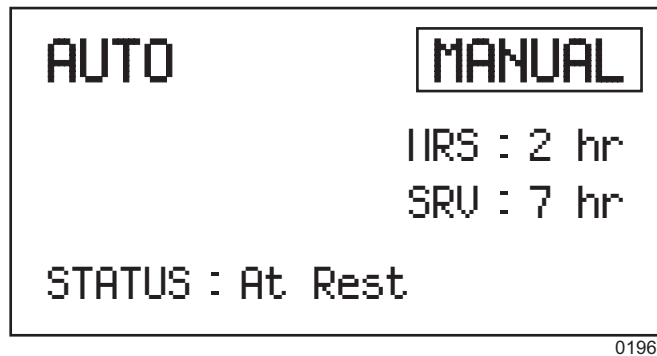
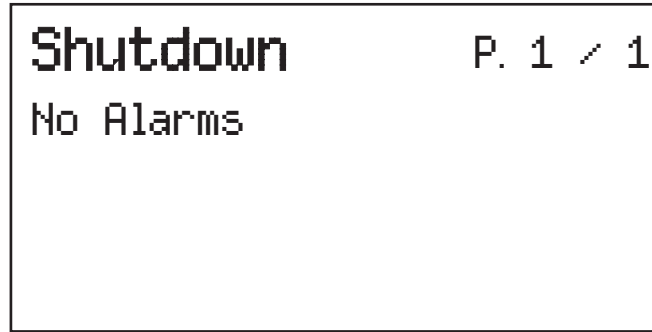

Figure 42 - Home Screen (MANUAL Mode)

Alarms Screen

The Alarms (A) screen(s) displays alarms, warnings, engine DTC alarms, and trouble codes. When an alarm occurs, this screen displays and the LED labeled STOP flashes.



02018

Figure 43 - Alarms screen

Warnings are non-critical alarm conditions that do not affect the operation of the generator system. By default, warning alarms are self-resetting when the fault condition is removed.

Electrical trips are latching and stop the generator in a controlled manner. On initiation of the electrical trip condition, the controller de-energizes all the outputs, including the lights, to remove the load from the generator. Once this has occurred, the controller starts the cooling timer and allows the engine to cool off before shutting down the engine.

Shutdown alarms are latching and immediately stop the generator. On initiation of the shutdown condition, the controller de-energized all the outputs, including the lights, to remove the load from the generator. Once this has occurred, the controller shuts the generator set down immediately to prevent further damage.

Diagnostic Trouble Codes (DTC) alarms are detected by the engine ECU and displayed by the controller.

Fault	DTC Description
Check Engine Fault	The engine ECU has detected a fault not recognized by the controller, contact the engine manufacturer for support.
Low Oil Pressure	The engine ECU has detected that the engine oil pressure has fallen below its configured low oil pressure alarm level.
Under Speed	The engine ECU has detected that the engine speed has fallen below its configured under speed alarm level.
Over Speed	The engine ECU has detected that the engine speed has risen above its configured over speed alarm level.
Low Fuel Level	The engine ECU has detected that the engine's fuel level has fallen below its configured low fuel level alarm.
Battery Under/Over Voltage	The engine ECU has detected that the engine's DC supply has fallen below or risen above its configured alarm level.

To view the active alarms, repeatedly press the ↑ and ↓ buttons until the LCD window displays the alarm.

Continue to press the ↑ and ↓ buttons to scroll through the alarms.

To exit the alarm screen, simultaneously press the ↑ and ↓ buttons to access the navigation menu. Then, scroll to the desired operator screen.

Note: The alarm condition must be resolved before a reset will take place. If the alarm condition remains, it is not possible to reset the unit. The exception to this is the Low Oil Pressure alarm and similar active-from-safety-on alarms, as the oil pressure is low with the engine at rest.

To remove the fault of the latching alarms, see [Manually Starting the Unit](#).

Note: The LCD backlight is on if the unit has sufficient voltage while the unit is turned on, unless the unit is cranking for which the backlight is turned off.

If the controller is left in STOP mode for a period of inactivity, the controller enters POWER SAVE mode. To activate the controller, press STOP (O).

Maintenance Screen

The Maintenance screen (🔧) displays maintenance alarms. The three alarms are for servicing the fuel filter, oil filter, and air filter.

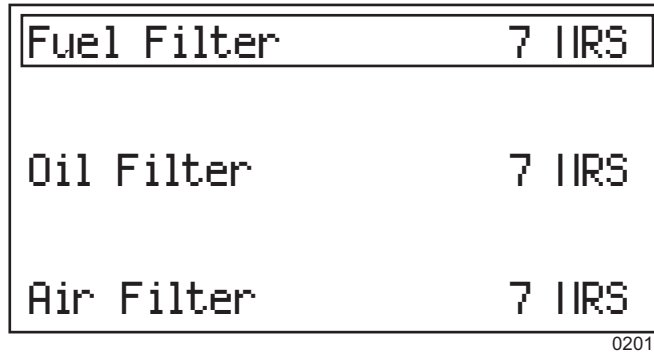

Figure 44 - Maintenance Screen

Event Log Screen

The event log (📄) displays the 15 most recent *electrical trip* and *shutdown* events, and the engine hours at which they occurred.

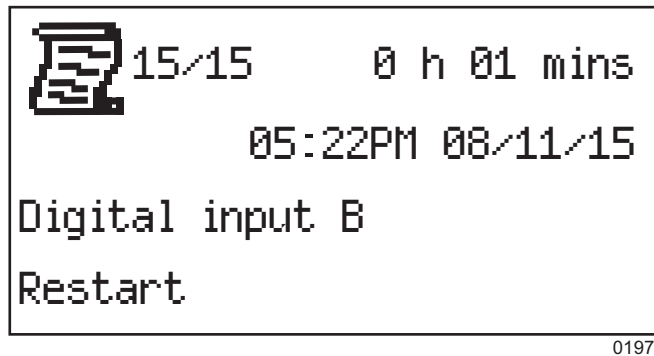



Figure 45 - Event Log Screen

Viewing the Event Log

1. Display the navigation menu by simultaneously press the ↑ and ↓ buttons.
2. Access the event log section.
3. Press the AUTO button.
4. Scroll through the log by pressing the ↑ or ↓ button.
5. Exit the event log by simultaneously pressing the ↑ and ↓ buttons.

About Screen

The About () screen displays information about the controller, such as date and time, the product and USB identification number, and the application and engine versions.

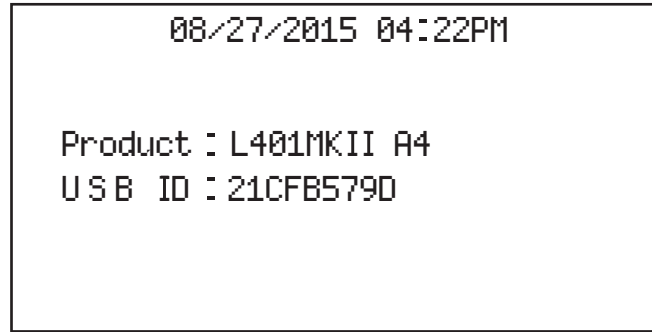

01970

Figure 46 - About Screen

Manually Starting the Unit

All units equipped with the Power Zone controller will initially start up in STOP mode. Use the following procedure to start the generator in MANUAL mode.

1. Verify the main circuit breaker and the individual circuit breakers for each of the lights are OFF (O).
2. Move the Control Power switch to ON (I).
3. When the controller powers up, the Home screen will be displayed and the controller will be in STOP mode as indicated by the Stop LED being lit. Press the Start button to initiate the startup procedure and start the engine, provided that there are no engine faults preventing the unit from starting. The Start LED will now become lit.

Note: *The controller can be started from any screen. It may take a few seconds for the engine to run smoothly and reach its governed operating speed.*

4. If the engine does not start after the first cranking attempt, the engine will pause for 15 seconds to allow the starter to cool. The controller backlight switches off. The engine will make two more attempts to start for a total of three crank cycles.
5. Should the engine not start and run within three starting cycles, the screen displays the Fail to Start alarm. The starting sequence may be repeated after the starter has had a minimum of two minutes to cool. Pressing the Stop (O) button will clear the alarm and reset the controller.
6. Once the engine starts, it will immediately begin speeding up to a constant 1800 rpm. The engine may hunt or change speeds until operating speed is achieved. After a few minutes of operation, the engine will be warmed up and the Home screen will display the mode of the unit, the engine status, the engine RPM, and any program (Scheduler or Dawn to Dusk) in AUTO mode.
7. Check the generator for excessive noise or vibration and any coolant, oil, or fuel leaks before applying any loads.
8. Verify the frequency (Hz) is correct on the Generator screen. With no loads connected to the generator, the frequency should read approximately 60 Hz, depending on the type of engine governing used.
9. If all wiring connections have been made correctly, switch the main circuit breaker to ON (I) and then add any loads attached to the receptacles by switching the respective circuit breaker to ON (I). You will notice a slight change in engine sound when a load is applied to the unit.
10. Once the engine is running, allow it to reach normal operating temperature before switching on any loads.

Auto (Remote) Starting of the Unit

AUTO mode is used when the unit is started from a location other than the control panel by using a transfer switch. Auto (remote start) is the normal setting when the generator is being used as a standby power supply. Before putting the unit in the AUTO mode, review the Prestart Checklist section in the Operating Manual and Manually Starting the Unit section within these instructions. Also following any warnings and information on isolating the generator with a transfer switch if the unit is to be used as a standby power supply. Then continue with the steps described below.

1. Perform a manual start of the unit at least once to verify that the engine is operating correctly.

Note: *The lights are automatically disconnected on startup. The main circuit breaker can be left on if no other loads are connected, except for the lights. Any connected external loads must be disconnected by a transfer switch when starting the unit.*

2. If a check of the remote start circuit is desired:
 - a. Remove the wires from the remote start terminal block. Press the Select (✓) button to select AUTO. The Select LED will be lit.
 - b. Attach a jumper wire (minimum 16 gauge) across the two terminals on the remote start terminal block. This applies a ground to the Power Zone light controller to close the starting circuit contacts. The engine should crank, start and run.
 - c. Remove the jumper wire from the remote start terminal block and the engine will stop.
 - d. Reconnect any necessary wires from the remote start switch (transfer switch) to the remote start terminal block.
3. Confirm the unit is in AUTO mode. The Select LED should be lit.
4. Secure the unit by closing and locking all access doors.
5. The unit is now ready for remote starting.

Light Operation

The lights are turned on and off using the Power Zone light controller. To view the light screen, press the ↑ button three times from the Home screen.

Note: The lights can only be turned on and off while the unit is running in MANUAL mode.

⚠ WARNING

NEVER operate the lights without the protective lens cover, or with a lens cover that is cracked or damaged. The bulbs in the light fixtures produce high temperatures and operate under pressure. A broken or missing lens cover could cause the bulbs to shatter, causing injury.

1. Once the engine is up to temperature and running smoothly, switch the main circuit breaker to ON (I).

To turn the light(s) on, press the Select (✓) button. To turn the light(s) off, press the Select (✓) button.

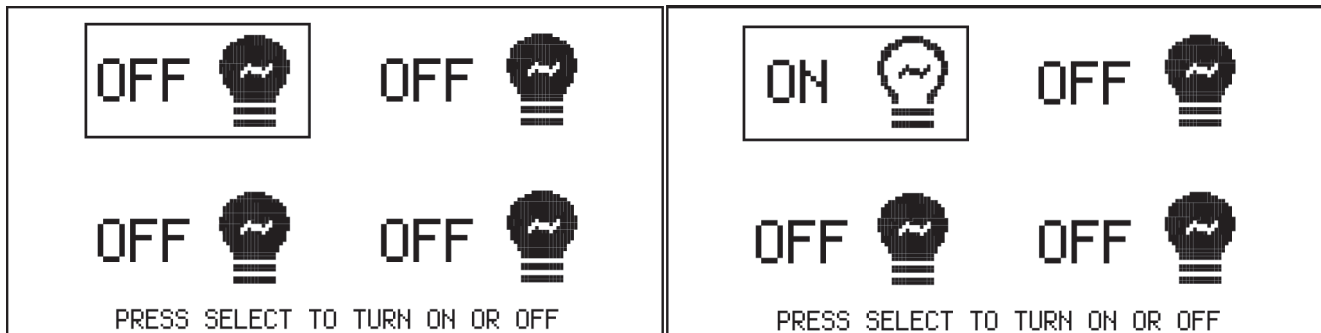

01972

Figure 47 - Switching Lights On and Off

2. The lights require a warm up period of 5–15 minutes before they reach full output. If the lights are shut down, they require a cool down period of approximately 10 minutes before they can be switched on again.
3. The light tower uses four 1000W bulbs. When checking or replacing the bulbs, wipe them with a clean cloth to avoid leaving any grease, oil residue or fingerprints on the glass. Any residue can create a hot spot on the bulb, causing premature bulb failure.

⚠ CAUTION

Bulbs become extremely hot when in use. Allow bulb fixture to cool 10-15 minutes before handling or lowering the mast.

Auto-Exercise Timer

The Power Zone controller can automatically start and stop the unit on a schedule of your choosing.

Units installed in a standby application should be exercised regularly to maintain operating condition and verify responsiveness in an emergency situation. Use the following procedures to operate the unit in AUTO mode.

Accessing the Scheduler

1. Press \uparrow or \downarrow until the scheduler screen displays.

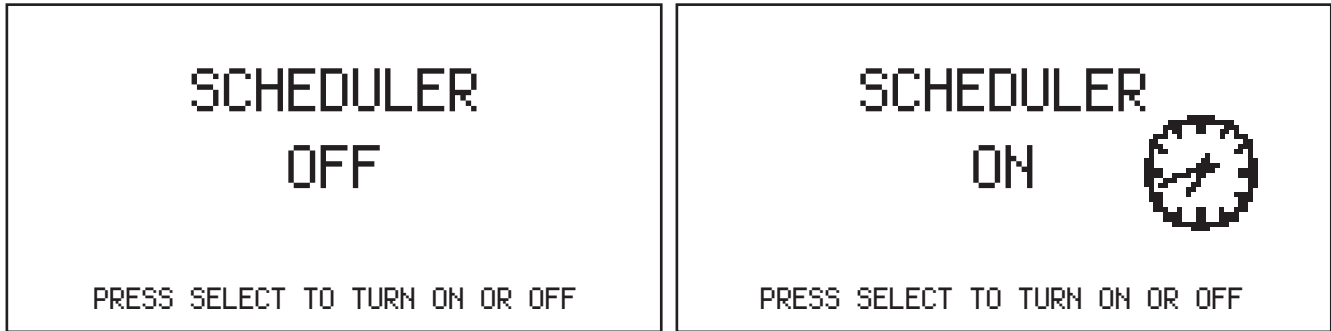

02014

Figure 48 - Scheduler Screen

2. Press \checkmark to either enable or disable the scheduler. When the scheduler is on, the seven scheduler screens will become active. After five seconds of inactivity on the main scheduler screen, the display will automatically jump to the Monday scheduler screen. If it does not, press \downarrow to enter the Monday scheduler screen.

Setting the Controller Clock

The schedule runs according to the time set in the controller clock. Use the following procedure to set the controller clock before setting the schedule.

1. Press \checkmark during the five seconds the main scheduler screen to make the date and time editable. The date is formatted as MM/DD/YY and the time in the 12 hour format.

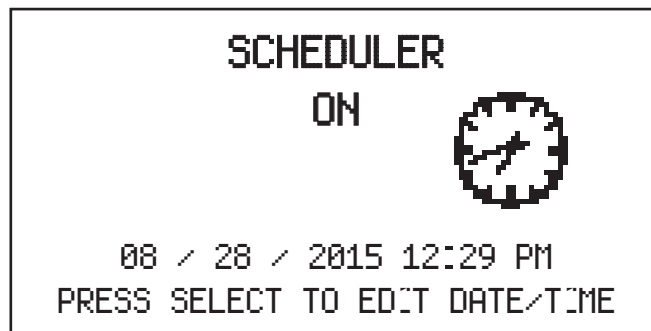

02013

Figure 49 -

2. Once \checkmark is pressed, the first number is highlighted. Pressing \uparrow or \downarrow goes through the items and pressing \checkmark on any one item makes it editable. When \checkmark is pressed on an item, the item will flash. Set the time and date to the correct local time.

Setting the Schedule

Note: The controller must be in AUTO mode to run at the programmed time. Use a trickle or solar battery charger to prevent the controller from draining the battery while in AUTO mode.

1. With the Scheduler on, press ↓ to enter the scheduler starting with Monday.

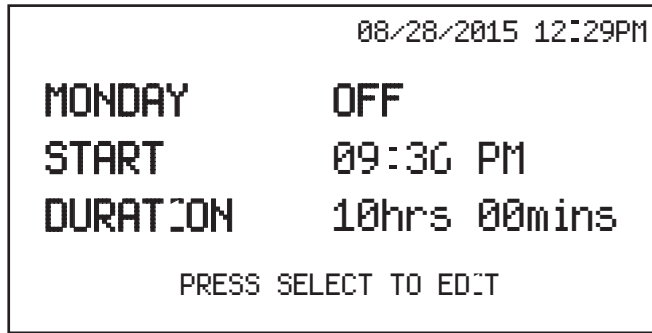

02015

Figure 50 -

- a. To edit the day, use ↑ or ↓ to get to the desired day. Press ✓ to turn the day on or off.
- b. The start time and duration are adjusted whenever the number set is highlighted. Use ↑ or ↓ to change the value.

Note: The duration can only be set in five minute intervals.

Setting Dusk to Dawn

1. Press ↑ or ↓ until the dusk to dawn screen is displayed.
2. Press ✓ to turn the photo eye on or off. Actual sensitivity of the photo eye must be adjusted at the mast.

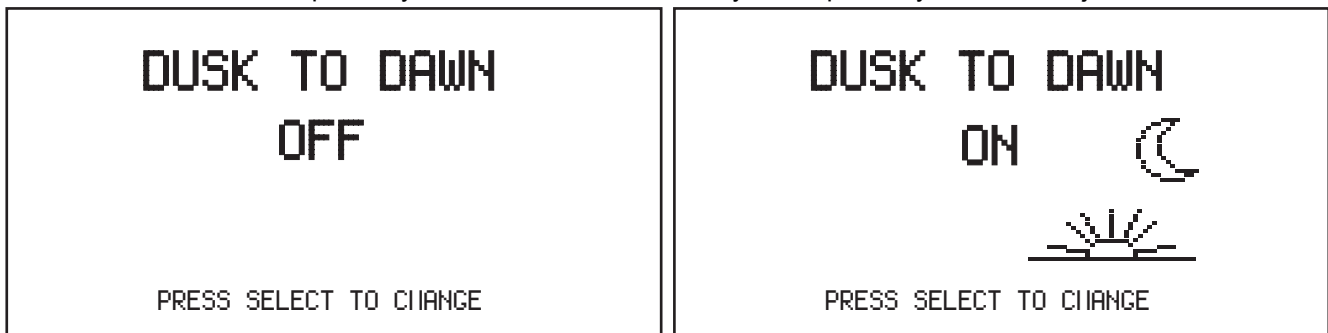

01971

Figure 51 - Dusk to Dawn Screen

Setting the Unit to AUTO Mode

1. From the Home screen, press ✓ to toggle to AUTO mode.

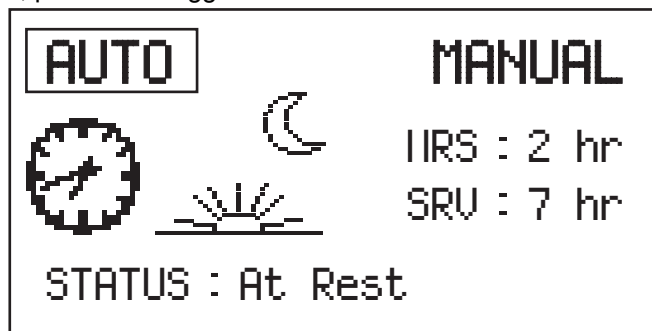

01969

Figure 52 - Home Screen (AUTO Mode)

Note: If any of the scheduled time slots are currently active, the controller will begin the starting sequence and start the unit provided there are no shutdown conditions present.

Resetting Maintenance Alarms

The Power Zone™ controller will display a warning message when the unit is due for maintenance or service. The maintenance or service interval is set at 250 and 500 hours of engine running time. Once the unit has been serviced, the appropriate maintenance alarm reminder needs to be reset. The following procedure demonstrates how to reset the maintenance alarms.

1. With the unit shut down, move the Control Power switch to ON (I). After initialization, the controller will toggle automatically to the Home screen.
2. Press ↑ and ↓ simultaneously to enter the navigation menu.
3. Press ↑ or ↓ to move  to the top of the screen. Press ✓ to enter the Maintenance screen.
4. Press ↑ or ↓ to highlight the desired alarm that needs to be reset. Press ✓ to start reset.
5. Enter the PIN **4444**. To do this, press ✓ and then ↑ or ↓ to adjust the first number of the maintenance PIN. Press ✓ to continue to the next number.

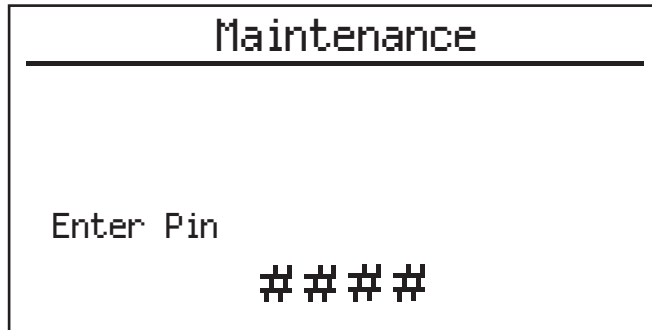

02026

Figure 53 -

Note: If the incorrect PIN is entered, the Home screen displays.

6. The desired maintenance alarm hours will begin to flash. Press ✓ to reset the selected alarm.
7. To perform additional maintenance alarm resets, repeat steps 4–6.

Shutting Down Unit

Check with personnel using power supplied by the unit and let them know the power is going to be turned off. Make sure the power shut down will not create any hazards by accidentally turning off equipment that needs to be kept on (pumps, compressors, lights, etc.).

1. Remove all loads from the receptacles.
2. Switch the individual circuit breakers for each light to OFF (O). (For MLT and MTT only.)
3. Switch the main circuit breaker to OFF (O).
4. Press STOP (O).
5. After the unit shuts down, switch control power to OFF (O).

Note: For extended storage time, disconnect the battery. For extended storage requirements, see the engine manual.

AC Wiring Diagram

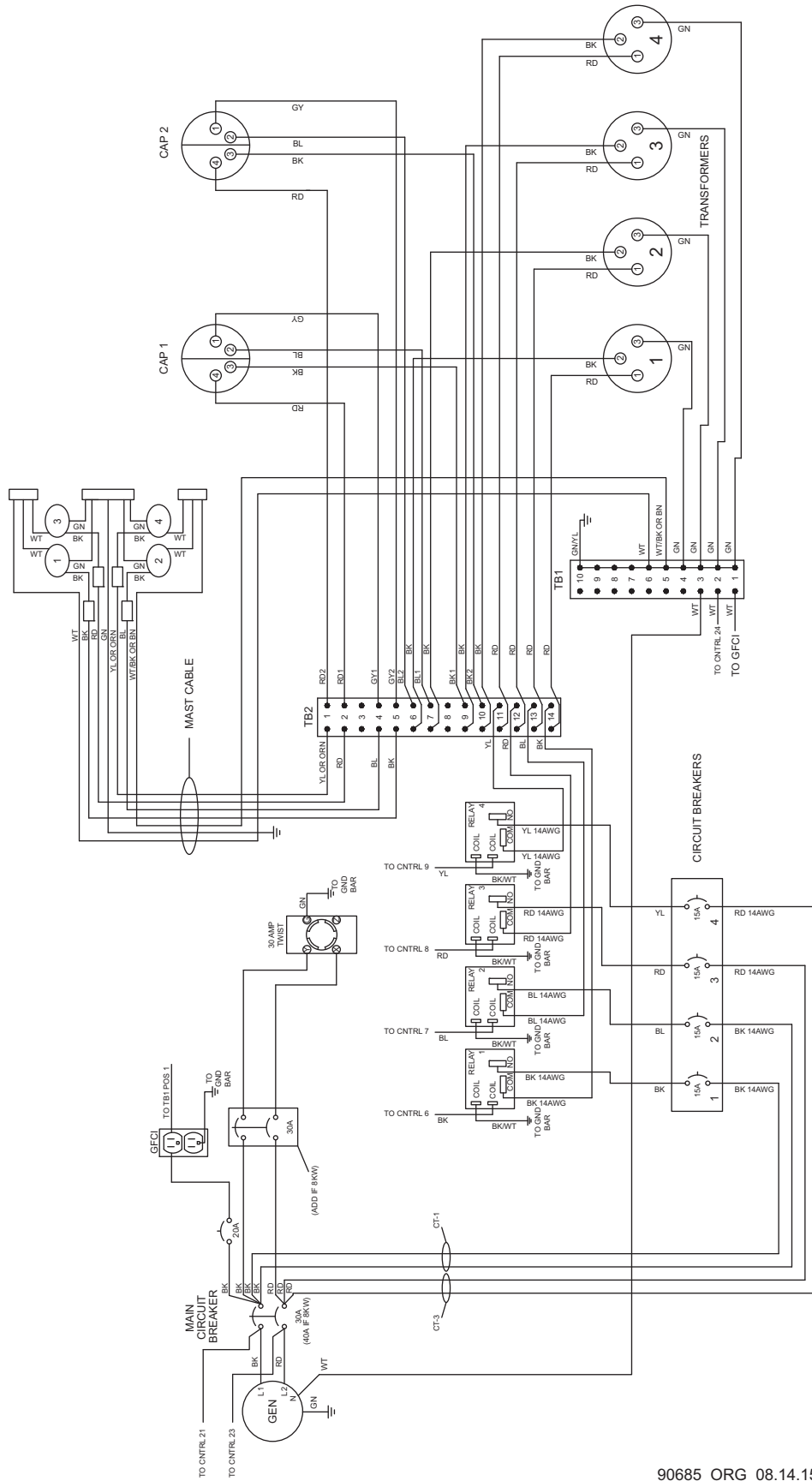

90685_ORG_08.14.15

DC Wiring Diagram

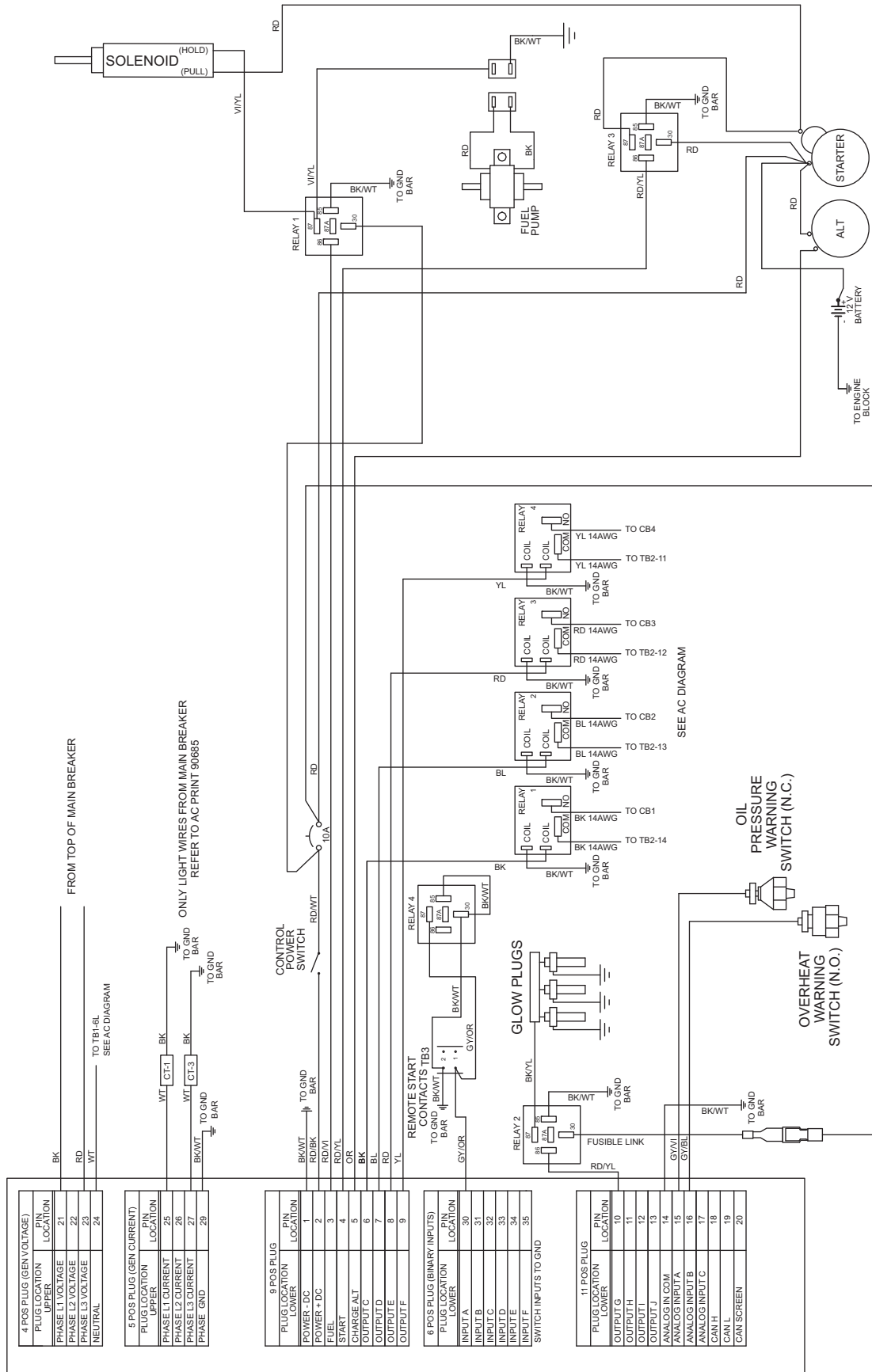

90684_B_09.30.15

